

**INSTRUCTION MANUAL
AIR HEATER
TYPE DXC**

GB 550c

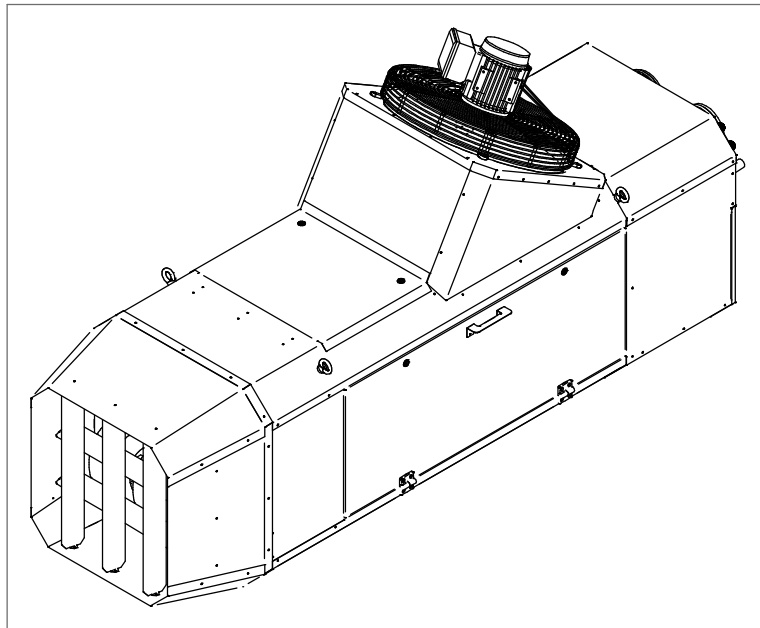

THIS DOCUMENT MUST ABSOLUTELY BE READ BEFORE STARTING THE
INSTALLATION.
INSTRUCT USER AND LEAVE THIS DOCUMENT WITH THE HEATER FOR
REFERENCE.

Instruction manual version GB550c
Heaters for GB
Date: 2015
Heaters for natural gas G20 and Propane

1 Introduction:

This installation and user manual contains the installation and users instructions for the standard and axial model of the TR-series. For the centrifugal, duct or air curtain models, additional instructions are provided in an appendix. This manual is produced specifically for the gas, electrical and mechanical installer. Also, it contains instructions how to install, use and maintain the heater. To assure a safe and efficient operation of this unit air heater, it is absolutely necessary to apply the instructions in the manual(s) correctly.

2 Content:

	Page
1 INTRODUCTION:	2
2 CONTENT:	2
2.1 GUARANTEE	3
3 APPLICATION RESTRICTIONS	3
3.1 PRE-CHECK	3
3.2 PROTECTION DEGREE	3
4 TECHNICAL DETAILS:	4
4.1 DXC80	4
5 INSTALLATION	5
5.1 POSITIONING	5
5.2 GAS CONNECTION	6
5.3 ELECTRICAL CONNECTION	6
5.4 AIR INTAKE / COMBUSTION PRODUCTS DISCHARGE	7
5.5 AIR INTAKE FROM INSIDE B22	8
7 FUNCTIONING OF THE UNIT	8
7.1 GENERAL	8
7.2 HEAT DEMAND	8
7.3 VENTILATION	9
7.4 HIGH LIMIT PROTECTION	9
7.5 DESCRIPTION HEATER CONTROL HC	9
8 PUTTING INTO OPERATION AND ADJUSTMENT	10
8.1 GENERAL	10
8.2 FUNCTION SWITCH ON THE FRONT OF THE HEATER	10
8.3 START BY USING THE SERVICE-BUTTON	11
9 ADJUSTING THE GAS-CONTROL	11
10 PROBLEM SOLVING	12
10.1 GENERAL	12
11 MAINTENANCE	14
11.1 BASIC CLEANING THE HEATER	14
11.2 GENERAL MAINTENANCE	14
11.3 SPARE PARTS	15
12 ELECTRICAL DIAGRAM	16
13 CERTIFICATES	17

General

The DXC heaters are direct fired gas heaters with an output up to 80 kW. The heat exchanger is built with S-shaped tubes, each having its own atmospheric burner. Depending on the power of the heater, there are more burners and tubes in one appliance.

Further the heater is provided with a sophisticated control sequence to maintain a safe and reliable operation.

It is imperative that the installation and maintenance of this appliance are carried out by qualified gas engineers, and strictly according to our instructions.

2.1 Guarantee

The guarantee is invalidated when the air heaters are not installed in accordance with this manual.

3 Application restrictions



Important!

The installation and maintenance of this air heater should be performed by an authorised competent installer in accordance with this manual.

This appliance is not intended for use by persons (including children) with reduced physical, sensory or mental capabilities, or lack of experience and knowledge, unless they have been given supervision or instruction concerning use of the appliance by a person responsible for their safety.

3.1 Pre-check

Before unpacking and installation, please check (i.e. on the data badge) if the heater corresponds to the order and if it is suitable for the local present provisions (gas type, gas pressure, electrical supply etc.)

The installation must comply with all applicable local and national standards.

The installation of the air heater must be in accordance with the relevant requirements of the Gas Safety Regulations (for example in GB; The Institute of Gas Engineers IGE UP-1 and 2), Building Regulations and the IIE Regulations also incorporating the gas safety (installation and use) regulations. Other national and/or local regulations may apply (the Local Authority, Fire Officer and Insurers)

The competent installer must make sure the heater operates correctly and must instruct the user about the safe operation of the heater.

The heater should not be installed in areas containing aggressive or explosive vapors.

The heater can be used in poultry houses, but has to be cleaned after every batch of animals, or sooner if the pollution degree requires it. Otherwise the guarantee will become invalidated.

The heater has been tested in detail on safety and correct operating settings before leaving the factory. It has been adjusted for the type of gas that is stated on the data badge. Should there be any doubt, please contact your supplier.

3.2 Protection degree

The heater has a protection degree of IPX4D. That means protection against splash water from any direction. That means no water pressure cleaner!

However the heat exchanger can be cleaned by means of a water pressure cleaner.

Do not spray with pressure water on the electrical motor or on the machine cover from the electronics. Those parts can with stand water, but not from a pressure cleaner.

4 Technical details:

4.1 DXC80

General	
Maximum nominal input Qn (Hi)	83,0 kW
Minimum nominal heat input (Hi)	53,5 kW
Efficiency max	91,5 %
Maximum heat output	75,9 kW
Minimum heat output	47,1 kW
Air volume	8,000 m ³ /h
Throw	45 m
Weight	150 kg
Dimensions (b x d x h)	650 x 2090 x 1080 mm
Permissible ambient temperature	0 - 40 °C
Noise level (at 4m)	68 dB(A)
Fan diam / angle.	Ø 508 mm / 30°
RPM Fan	1400 rpm
Flue connection	130 mm / 130 mm parallel

CE-information	
norm(s) directives the heater complies with	Gas Appliance Directive 2009 / 142 / EC Low Voltage Directive 2006/95/EC EMC Directive 2004/108/EC EN 1020 / 2009 (non domestic gas fired air heaters...) EN 60335-2-102 / 2006 EN 60335-2-102-A1 / 2010 EN 55014-2 (EMC) NOx legislation (NL) KB344 / 1995

Safety settings	
Air pressure switch	0,75 mbar
Limit thermostat (NTC)	110 °C

Gas	G20	G25	G31
nominal gas consumption	8,8 m ³ /h	9,9 m ³ /h	l/h 6,6 kg/h
nominal gas supply pressure	20 mbar	20 / 25 mbar	30 / 50 mbar
Appliance category	II2H3P	II2L3P	II2H3P
minimum gas supply pressure	17 mbar	18 mbar	25 mbar
maximum gas supply pressure	25 mbar	30 mbar	57,5 mbar
nominal burner pressure (High / Low)	7,4 / 3,2 mbar	11,0 ./ 4,5 mbar	19,5 / 8,1 mbar
gas pipe diameter	G 3/4"	G 3/4"	G 3/4"
nozzle diameter	6 x 3,7 mm	6 x 3,7 mm	6 x 2,3 mm
CO ₂ indication (High)	8,3 %	8,5 %	9,2 %
NOx klass	3	3	3

Electricity	
mains voltage	230 V (min 195V max 245V)
Frequency	50 Hz (+/- 3 Hz)
maximum current requirement	3,9 A
Rated power	900 W
Thermostat connection	24 V

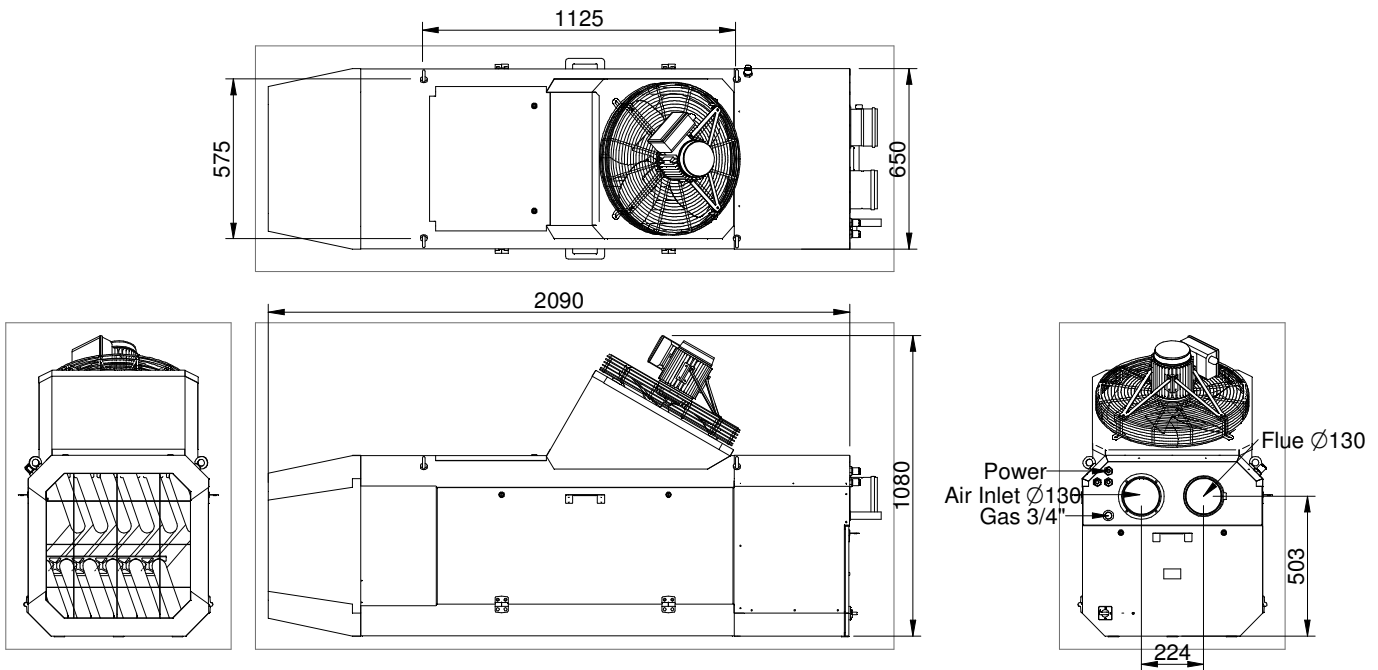

5 Installation

5.1 Positioning

- Check and make sure that the support is solid enough.

Keep sufficient distance between the heater and any obstruction. Take into account the possibility to open and access the service doors of the heater for service and cleaning. Pay particularly attention to any flammable materials. Make sure the airflow to and from the heater is unhindered. A ventilation gap is required from the top and bottom of the heater to any flammable materials. Make sure that the warm air can be blown out freely. There should absolutely be no (possibility of) materials within 5m from the front of the heater. See the drawing for the safe distances.

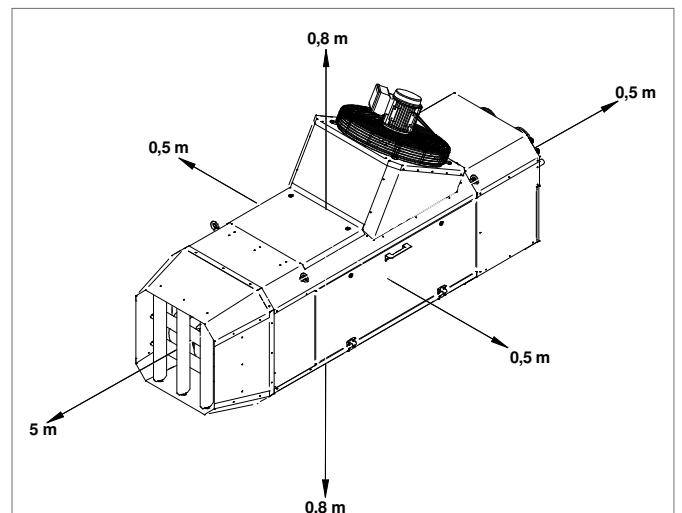

- The heater is provided with 4x M10 sockets on the top and on the bottom. See technical drawings.
- Make sure that after fitting, there is no mechanical tension on any connecting gas or electric supplies.
- Install the heater Horizontally

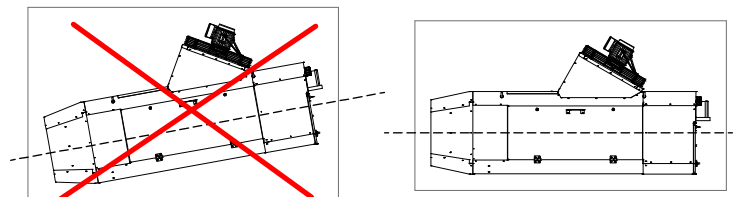

Attention:

See the application-restrictions in this manual (Chapter 4) for more installation restrictions.

5.2 Gas connection

The gas supply line has to meet the national valid requirements and possibly the local requirements of the building inspector, police or fire brigade. (In GB it must comply with Gas Engineers publication UP-1 and UP-2 together with BS 6891.)

A manual isolation valve in the supply line must be placed within reach of the heater, and all gas lines must be mounted without any mechanical tension.

When testing the supply lines with pressures above 60 mbar, this manual valve at the heater must be closed.

The working and standing supply pressure must be between **17mbar and 30mbar**, measured at the inlet pressure nipple of the gas control in the heater.

The burner pressure is pre-adjusted (high/low, see technical details). The burner pressure can be measured on the P-out measure point on the gas valve.

5.2.1 Changing the gas type



There is a kit available for changing the gas type. (from natural gas to propane or vice versa) The gas nozzles have to be exchanged and the burner pressure readjusted. Look into the specifications for the exact adjustments. Instructions can be found in this manual.

5.3 Electrical connection

5.3.1 230Vac supply

The installation must comply with local and national requirements, (as well as IEE regulations). The unit heater is delivered completely internally wired. Where controls of any type are to be added (e.g. room thermostat), the relevant wiring diagrams must be followed. Never use a room thermostat to interrupt the electrical supply to the heater!

Make provisions to completely isolate the heater for maintenance purposes. This can be an isolation switch (min. 3mm contact opening gap), a power plug or a non-switched fuse spur. The wiring diagram for the heater can be found towards the end of this manual.

The supply is 230Vac. with earth. The control circuit is two wire 24V.



Voltage restrictions:

The supply is 230Vac 50Hz with earth. When the supply voltage is lower than 195V and higher than 255V the correct functioning of the heater is not guaranteed. The tolerance on the frequency is +/- 3Hz

5.3.2 Simple ON / OFF contact with thermostat relay in heater

(standard configuration see schematic in this manual)

The heater is supplied with an internal 24V transformer in the thermostat circuit.

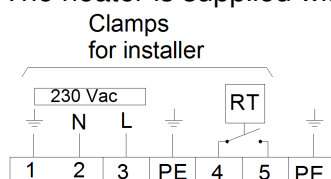

This transformer switches a relay for the on/off signal in the heater.

Every heater has to be switched by a **separate** ON/OFF contact in the control room. (potential free contact)

Do not connect more than one heater to each other under the same contact.

The following (Standard) settings on the main board in the heater have to be actual.

- The S2 micro switches on the main board have to be set to OFF, see example.
- The switch S3 has to be set to 1.
- The thermostat has to be connected to the clamps 4 and 5 in the heater.

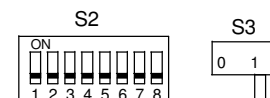

(Any changes too these switches must be performed with the power off, otherwise any changes made will not take effect.)

5.3.3 Fuses

On the heater control (HC) there are two fuses. (See electrical wiring diagram.) F1 and F2 (T5A) are in the power supply of the heater. Replace the fuse only by a fuse of the same type. The fuse F3 (T0,05A) protects the 24V transformer in the thermostat circuit

5.4 Air intake / combustion products discharge

Check for compliance with local/national regulations.

The combined Winterwarm combustion-air supply/combustion-gas outlet device (roof terminal or wall terminal) has to be used, only then the installation is CE approved. See installation drawings.

Never connect a roof terminal for condensing appliances; rain can damage the heater through the discharge pipes.

Make sure the roof terminal is at least 0,5m above roof level. Use only pipes and bends for overpressure with profiled sealing-rings.

5.4.1 Maximum flue length

Vertical: 9 meters is the maximum length between the heater and its flue outlet.

Horizontal: 6 meters is the maximum length between the heater and the flue outlet.

When bends are used, the pressure drop will increase and therefore a 90° bend will count as 2 metres and a 45° bend as 1 metre. All flue pipes must be of the same diameter as the flue spigots on the heater, and all flue joints must be sealed. For further information regarding the flue system please contact your supplier.

5.4.2 Air intake from outside C12, C32

In case of a vertical flue outlet, the outlet must at least point out 0,5m above the roof surface.

Make sure that the air intake openings are free of any obstruction.

Always take the local regulations into account.

5.4.3 Installation examples flue system

Vertical discharge system:

Flue terminal : IA8305

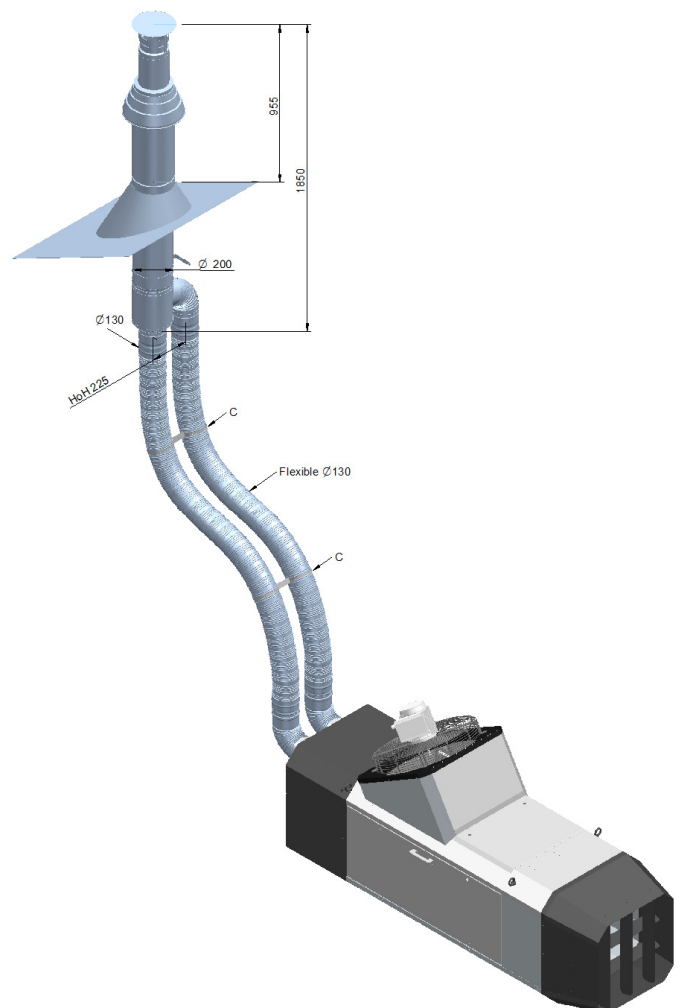

Horizontal system:
Flue terminal: IA8312

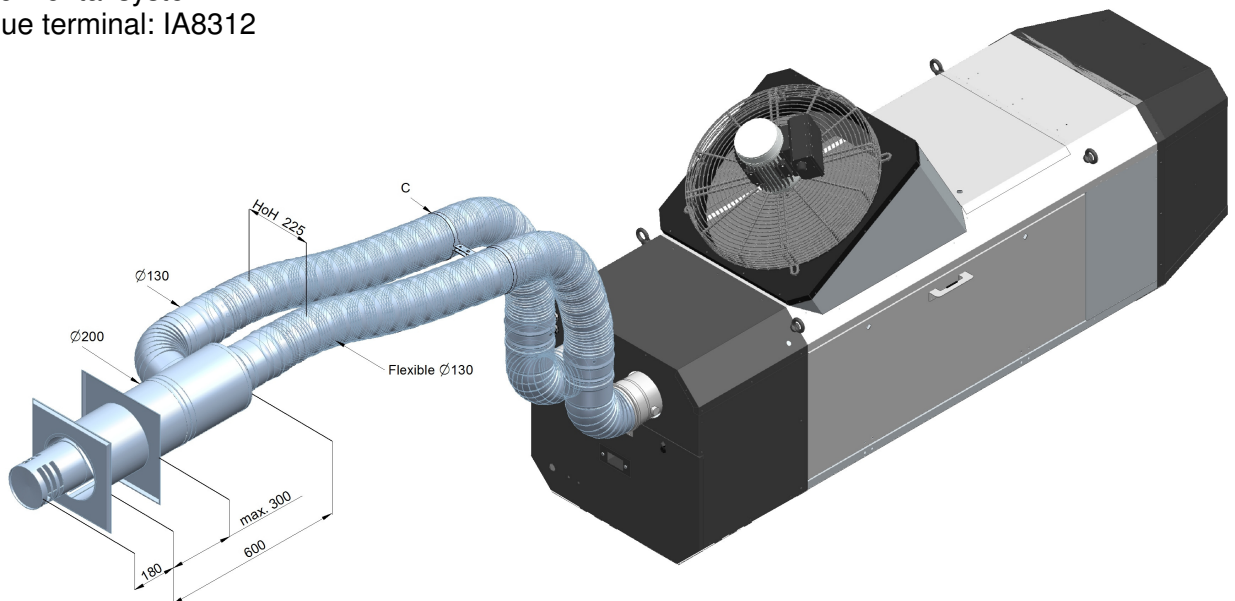

5.5 Air intake from inside B22

Because of the pollution level inside the heated space, it is not allowed to take the air from the heated space. Always take the fresh air from outside through the certified wall and roof terminals.

7 Functioning of the unit

7.1 General

The unit can heat as well as ventilate. The mode that the heater should work on can be selected by means of the control switch on the heater.

7.2 Heat demand

If the thermostat indicates heat demand, the following cycle will start:

1. **Pre purge:** The electronic circuit board acknowledges the heat-demand and the flue booster fan will start running for 30 seconds. (Display print → 1)
2. **Ignition:** After 30 seconds of pre purge, the electrode will spark for max. 5 seconds, the gas valve is opened and the gas-air mixture will ignite. (Display print → 2)
3. **Burn:** When the flame is detected (Display print → b) the unit will modulate to the desired load after ca. 15 seconds. Depending on the given load, the system fan will start modulating (step-less) as well. The air heater will **always run for a minimum of 4 minutes**. This is to evaporate eventual condense in the discharge system.
4. **End of heat demand:** When the heat demand ends, the burner will switch off and the system fan will continue to run for ca. 3 minutes in order to cool the unit down (Display print → P).

The unit will try to ignite twice before lockout on flame fault.

In the case of flame failure during operation, the heater will attempt one restart.

When the heater is in lockout you see in the display intermittent A1. On the display of the room thermostat you see failure 1.

7.3 Ventilation

With the control switch on the heater the unit can be set to the ventilation mode. In that way the unit will always ventilate. A heat demand is also acknowledged. So the heater will still burn when necessary.

7.4 High limit protection

The unit is equipped with a temperature sensor. This NTC sensor is mounted in the front of the heater. It monitors the air temperature electronically.

There are 4 important temperature levels detected by this sensor.

1. Temperature lower than 80 °C
 - Normal functioning.
2. Temperature between 80 °C and 90 °C
 - Burner at minimum stage
3. Temperature between 90 °C and 110 °C:
 - Error E1 will blink on the display.
 - The burner is switched off
 - The fan cools the heater
 - When the temperature is below 70 °C degrees, the heater will automatically restart. The Error E1 will disappear.
4. Temperature above 110 °C
 - Error A2 will appear on the display
 - The burner had already stopped
 - The fan was already cooling the heater down.
 - When the heater cooled below 70 °C the heater will not restart automatically. This error can only be reset manually.

7.5 Description heater control HC

The heater control (HC) controls the unit and communicates with the room thermostat.

Functions integrated in the heater control HC are:

- two wire contact with room thermostat
- spark ignition to burner
- ionisation flame guard on burner
- controlling the gas valve
- modulating the burner
- controlling the system fan
- guarding the temperature of the heat exchanger
- LED signals status of heater, heat demand: green, failure: red
- Status of heater on 8 segment display on heater control HC
- reset of heater
- service mode function

Lay-out print board

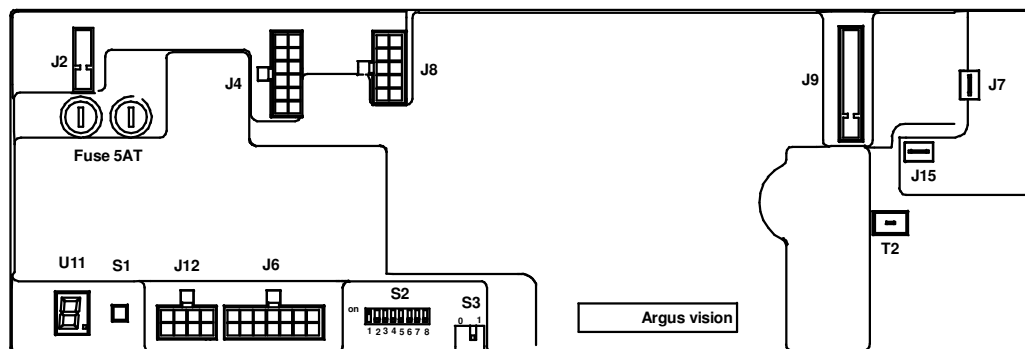

J2 Main power connection 230V

J4 Connection for gas valve and system fan

J6 Connection for room thermostat, appliance recognition and the status LEDs green and red

J7 Earth burner
J8 Modulating coil gas valve, fluebooster
J9 not used
J12 Connections for temperature sensors
J15 Ionisation selector

F1 & F2 Fuses 2x 5AT

U11 Status display

S1 Reset service button
S2 Micro switch heater no. Standard all to OFF
S3 Power supply thermostat when S2 no.1 to “on”

T2 Ignition transformer, connection for igniters

8 Putting into operation and adjustment

8.1 General

Prior to packaging, each unit is checked in detail on safety and well functioning. It is among other things adjusted to the right efficiency of combustion. In general, the heater does not need to be adjusted after installation, only a check of well functioning is necessary by a competent person.

The high/low burner pressures can be adapted, if necessary. However, only do this when the burner pressure turns out to be incorrect after measuring (differences smaller than 0,5mbar do not need to be adjusted). Never touch the adjusters injudiciously!

In case the installation is done following these instructions, the unit can be put on. Make sure the gas line is clean, gastight and free from air.

Turn on the electrical supply with the main switch, and leave the door of the heater open, in order to watch the first start and so become familiar with the functioning of the unit.

In case of warmth demand, the heater will always run for at least 4 minutes, even if the warmth demand is fulfilled within this time.

The heater will attempt twice to start again, before going on flame failure. Then reset is necessary.

Do not forget to instruct the end user about a safe use of the heater (presence of gas, place of the manual gas valve!), the operation of the heater (lock-out indication and reset) and about the necessary maintenance. This manual must be left with the end user.

8.2 Function switch on the front of the heater

0 OFF

The power to the electrical components is interrupted, Neutral and Live. The Earth connection is not interrupted. The heater is OFF. The internal supply wiring to the function switch is still Live.



1 Auto

The heater is Live and will start to burn when the thermostat connection is made.



2 Fan

The fan from the heater is running. The heater will also burn when the thermostat connection is made.



3 Burn

The thermostat connection is manually made and the heater will start to burn.



4 Reset

When the heater is in Lockout, Blinking "A"-error, the heater can be reset by turning the switch shortly to the "4" position. The heater will reset itself.



8.3 Start by using the service-button

Besides operating with the function switch, the heater can also be started from the service button on the print board, near the display. Press the service-button once for 10 seconds, and the unit will commence the ignition-cycle; (30 seconds pre-purge, ignition, then burn)



The burner will then start on minimum load Display blinking → L/b.

By pressing the service-button again, the burner will go to maximum load. Display print → H/b

Pressing the service-button for a third time will put the unit back into normal operation (depending on if there is heat demand from the room thermostat).

Display on the print board

0	stand-by	Stand-by
1	Pre-purge	System checks and 30 sec. pre purge of the fluebooster
2	Ignition	The ignitionelectrode sparks 5 sec. and the gas valve opens, within 5 sec. flame detection should occur.
b	Burn	After 15 sec. stabilisation time, the heater will modulate to the desired power. The heater will run at least 4 minutes.
P	Post purge	The heater will cool the heat exchanger for 3 minutes, and the fluebooster will post purge for 1 minute.
F	Summer ventilation	The system fan is running on the summer ventilation mode.
L/1/2/ ... Blinking	Service Low	The heater is running on the service mode. When the heater runs, the heater will run on minimum power.
H/1/2/ ...Blinking	Service High	The heater is running on the service mode. When the heater runs, the heater will run on maximum power.

9 Adjusting the gas-control

In principle, it is **not** necessary to adjust the gas control after putting the unit into operation. In case it needs to be adjusted, (e.g. after fitting a new one), this must be done only by a qualified person. **Only use calibrated instruments!** A poor adjustment can lead to overheating and / or production of toxic carbon monoxide!

The burner pressures can be adjusted as follows:

- Remove the cover from the gascontrol with the help of a (small) screwdriver.
- Start the unit and first set the high burner pressure by turning screw (external 10mm). The High / low coil must be energised !
- De-energise coil (disconnect wire) and set low burner pressure by turning screw (slot for screwdriver) Do not set lower than 3 mbar in order to avoid problems with inter-lightning of burnerstrips.

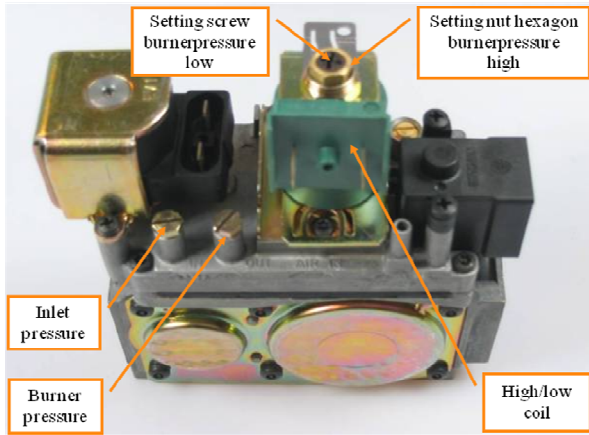

Attention: Always check each burner pressure after any adjustment, as they influence each other.

Always check the CO production of the heater!!! Too much CO usually means the mixture is too rich. Adjust this if necessary with the two adjusters (see above)

10 Problem solving

10.1 General

When it turns out that the problem is **not** caused by the external circumstances (i.e. no electric supply power or no gas), please take the following instructions into account. Please remember the built in waiting times of the heater (do not react too soon!) and the code on the display on the electronic circuit board.

To simplify the investigation of the failing heater please check first:

- the fuses as well as the wires and plugs in the heater for possible loose contacts.
 - Use first the service-button to put the heater in run mode, try later the room thermostat.

Volatile lock out : Can only be reset by hand

A0 Blinking	Internal failure	Defective print board
A1 Blinking	No flame	Within 5 sec flame, then flame failure: Cause 1 No flame: Cause 2
A2 Blinking	Exchanger too hot	Heater stops because the temperature of the heat exchanger is too high: Cause 3
A3 Blinking	Sensor error	Temperature sensor on heat exchanger error: Cause 4
A4 Blinking	Too many flame failures	Too many flame failures on ionization: Cause 1, 5
A5 Blinking	Internal error	Defective print board
A6 Blinking	Safety relays	2nd temperature limiter (optional) switched: Cause 3, 10
A7 Blinking	Flame	Flame detection when there should not be a flame

A/8 Blinking	Fluebooster	Fluebooster does not run: Cause 6 Fluebooster runs: Cause 7
------------------------	-------------	--

Non volatile lockout: will disappear when the error is cleared.

E/0 Blinking	Internal defect	Defective print board
E/1 Blinking	1st temperature safety	Heater stops because the temperature of the heat exchanger is too high. When the heater is cooled down, the heater will restart: Cause 3
E/2 Blinking	Selection resistance	Heater recognition does not work: Cause 8
E/3 Blinking	Selection resistance	Heater recognition does not work: Cause 8
E/9 Blinking	Reset error	Too many switches on reset button: Cause 9

Cause 1: Within 5 sec flame, then flames failure.

- The flame is not detected. Check the ignition cable and electrode. (cable resistance 1K ohm)
- The heater has electrically a poor earth.
- The print board is defective.

Cause 2:

- There is not enough gas pressure.
- The burner pressure is too low, adjust the gas valve
- The gas valve does not open, check during ignition on 230V on the valve.
- Check whether the ignition electrode sparks, replace cable, electrode

Cause 3: Heat exchanger too hot

- Check if the system fan blows enough air.
- Check the setting of the gas valve, the heater may be overloaded.

Cause 4: Temperature sensor on heat exchanger error.

- The sensor has internally 2 sensors. These differ too much. Measure the resistance from each sensor, the resistance should be 20K at 25° en 25K at 20°. If the measured values differ too much, replace sensor.
- Rotate the sensor ¼ turn, so that the contact point is different on the sensor housing.

Cause 5: Too many flame failures while burning

- The setting of the gas valve is not ok, adjust the gas valve
- The flue outlet is blocked

Cause 6: The fluebooster does not run

- fan is blocked or the wiring is bad
- fan is defective

Cause 7: The fluebooster fan runs.

- Check if the fan runs smoothly.
- Check if the fan is not polluted.
- Check if there is water (condense) in the hoses from the pressure switch.

Cause 8: Selection resistance error

- Check the appliance recognition part, replace if necessary

Cause 9: Reset button error

- Too many switches on reset button in a short period of time. This error will disappear after some time, or if the main power is disconnected for a while.

Cause 10: 2nd STB (optional) switched

- Heaters equipped with 2 system fans have a second temperature limiter. The second limiter has switched. Check the fan where this sensor is mounted.
- Check the wiring.

Heater does start, but shows other problems.

- a) System fan (M1) does not start. Check first the functioning of this fan by connecting it to 230 Volt. Check with a multi-meter if the different lower tensions are present on the fan. The fuse could have failed. If the motor is OK, the cause of the problem must be in the heater control HC, as the heater control HC dictates the different voltages to the fan-motor. In that case, replace the heater control HC.

11 Maintenance

It is recommended to have the heater checked and serviced by a service technician every year to guarantee reliable and safe operation. Heaters used in poultry sheds must be serviced and cleaned more often due to high levels of dust and dirt in these types of spaces.

11.1 Basic cleaning the heater



The heater must be disconnected from electricity during servicing. Disconnect the heater from the main power. Putting the function switch to “0” will not disconnect every part from the main power.

The heater can be cleaned with water. And some parts can withstand a pressure washer.

Do not spray with a pressure washer on the following parts:

- The big fan motor on the top of the heater. (the connection box will leak due to a pressure washer.
- The cabinet from the electronics. The rubber sealing from the access door will leak with a pressure washer.
- Be careful with the temperature sensor in the front of the heater. Do not spray too close on the wiring to the sensor.



The heat exchanger can be cleaned with a water pressure washer. The access doors will give a good view on the tubular exchanger. The water will flow out of the heater through the holes in the bottom.

11.2 General maintenance



To ensure the instructions below are carried out safely, it is recommended having these carried out exclusively by a service technician.



The heater must be free of electricity during servicing. Disconnect the heater from the main power. Putting the function switch to “0” will not disconnect every part from the main power.

Perform the following activities during general maintenance:



- Make sure the heater has been cleaned.
- Grease any parts and bolts that are loosened regularly for maintenance.
- Check whether the wiring, nuts and bolts are all properly tightened.
- Open the gas supply to the heater and check whether the heater and the gas hose and other connections are gas-tight.

Finally, carry out all the checks that are performed during heater installation (refer to Performing checks :

1. Measure the burner pressure;
2. Measure combustion values;
3. General heater operation.

Close the access panel once you have completed all checks. The heater may now be used again.

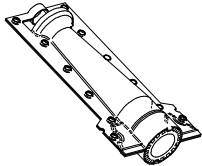
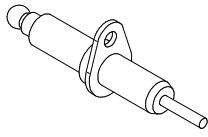
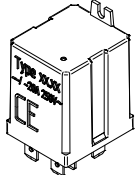
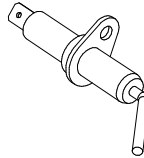
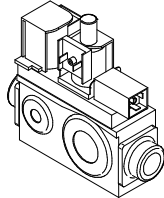
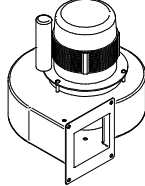
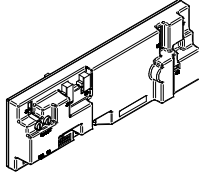
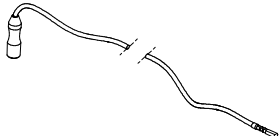
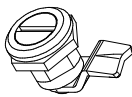
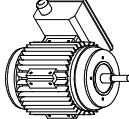
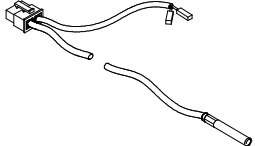
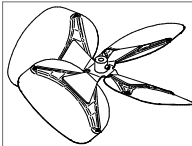
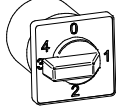
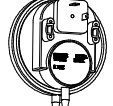
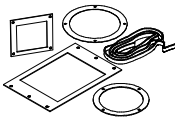
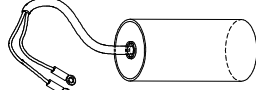
11.3 Spare parts

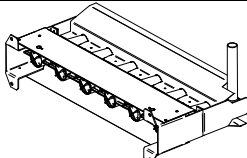
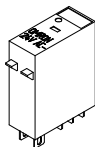
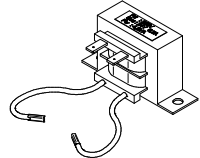
<p>Inshot Burners L Natural gas IB3202</p> 	<p>Ignition electrode TR, DXC IB3400</p> 
<p>Fan relay 230V~20A IK5200</p> 	<p>Ionisation electrode TR, DXC IB3402</p> 
<p>Gas valve IB3314</p> 	<p>Flue fan IB4516</p> 
<p>Control Board GD5908</p> 	<p>Ignition cable IB3929</p> 
<p>Lock IK6850</p> 	<p>Fan motor IP4806</p> 
<p>Temperature sensor DXC GD3923</p> 	<p>Fan blade IK4214</p> 
<p>Function switch GD5283</p> 	<p>Pressure switch IK3996</p> 
<p>Gasket set DXC GA6716</p> 	<p>Motor Capacitor main fan IP4809</p> 
<p>Flue fan capacitor IB4520</p> 	<p>Propane burner kit DXC GD2380</p> 
<p>Thermostat relay 24V IK5228</p> 	<p>Transformer DXC GD5103</p> 

12 Electrical diagram

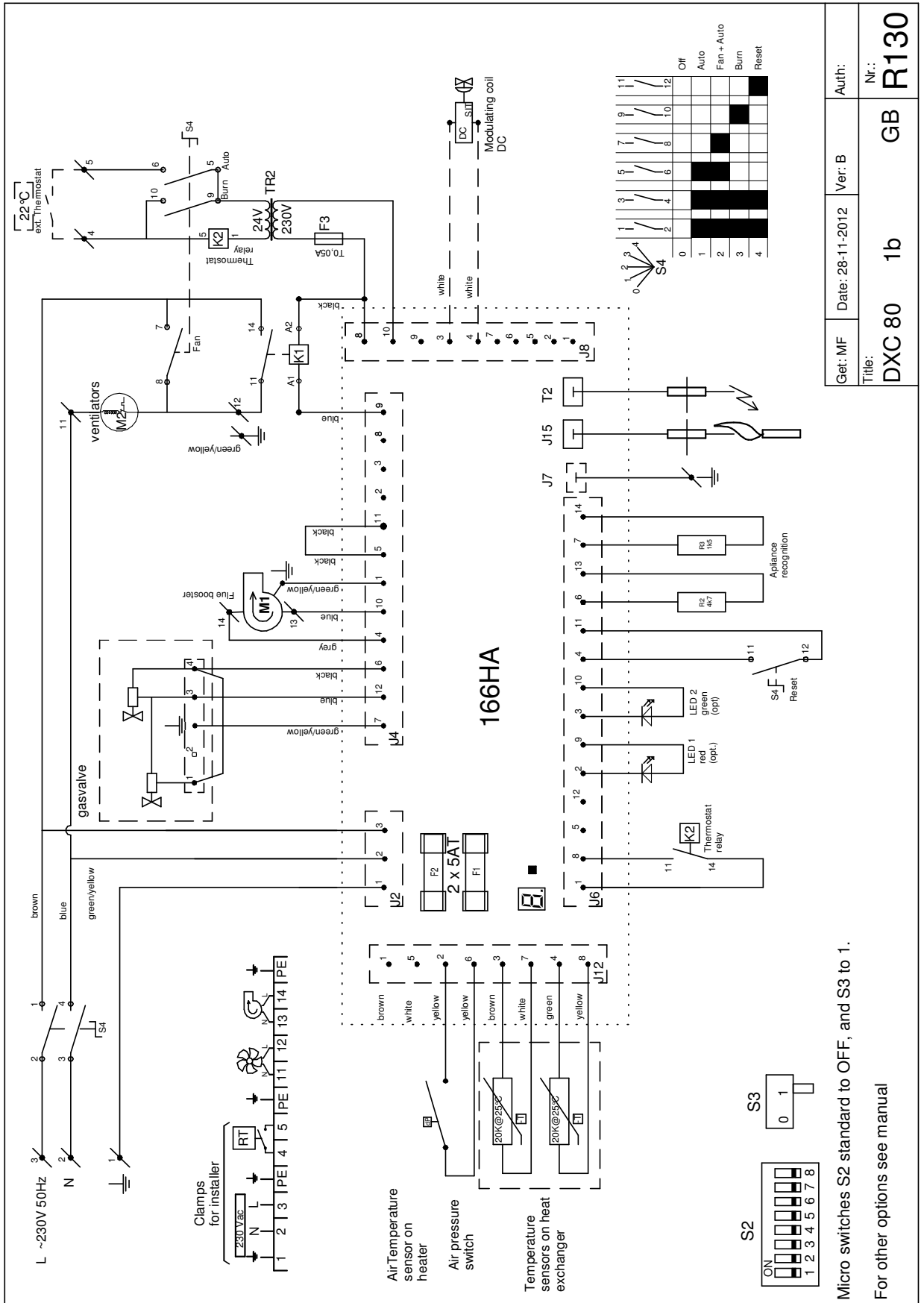

Get: MF	Date: 28-11-2012	Ver: B	Auth:
Title: DXC 80 1b	GB	Nr.: R130	

Micro switches S2 standard to OFF, and S3 to 1.
For other options see manual

13 Certificates



Partner for progress

Number: 59641/02
 Issued: 27-02-2013
 Report number: 177344-3
 PIN: 0063BR3344

Regulace: 59641
 Scope: 2009/142/EC
 Contract number: E 0450

EC TYPE EXAMINATION CERTIFICATE

Kiwa hereby declares that the gas fired air heaters, types
Winterwarm
 TR10, TR15, TR20 A/C/D;
 TR24, TR26, TR28, TR31, TR35, TR40 A/C/D/R;
 TR50, TR55, TR60, TR60-2, TR61, TR75, TR80, TR80-2 A/C/D/R;
 TR100, TR100-2, TR105, TR125-2, TR150-2 A/C/D/R;
 TR20, TR28, TR31, TR40 ACR,
 DXC80

manufactured by
Winterwarm
 Winterswijk, The Netherlands

meet the essential requirements as described in the
Directive on appliances burning gaseous fuels 2009/142/EC (ex-90/269/EEC).
 Appliance types
 : B22, C12, C32
 Appliance categories
 : I12EL3P, I12L3P, I12H3P, I12E3P, I12E3P,
 I12E(S), I12ELwLS3P, I12E(R), I3P

Countries: Austria Albania Belgium Bosnia-Herzegovina Bulgaria Croatia Cyprus Czech Republic Denmark Estonia Finland France Germany Greece Hungary Iceland Italy Latvia Lithuania Luxembourg Macedonia Malta Moldova Netherlands, the Norway Poland Portugal Romania Slovakia Slovenia Spain Sweden Switzerland Turkey Ukraine United Kingdom Yugoslavia	Liechtenstein Lithuania Luxembourg Macedonia Malta Moldova Netherlands, the Norway Poland Portugal Romania Slovakia Slovenia Spain Sweden Switzerland Turkey Ukraine United Kingdom Yugoslavia
---	---

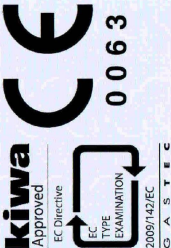

Kiwa Nederland B.V.
 Winterswijk 50
 P.O. Box 137
 7320 AC APELDOORN
 The Netherlands
 020 210 1000
 020 210 1001

GASTEC
 GASTEC
 GASTEC

ir. M. Meekema
 Director



heating solutions

Winterwarm BV
 Industrieweg 18
 NL-7100 AA Winterswijk
 The Netherlands
 Tel. +31 (0)243 548 300
 Fax +31 (0)243 548 310
 www.winterwarm.nl

CERTIFICATE OF COMPLIANCE

Winterwarm BV
 Postbus 36
 7100 AA Winterswijk
 HOLLAND

Declares that Hot Air Blower type:
 DXC80
 CE PIN: 0063BR3344

Are in accordance with the essential requirements of the relevant CEE
 directives concerning conception and construction being:

- Gas directive 2009/142/EC
- LVD directive 2006/95/EC
- EMC directive 2004/108/EC
- MD directive 2006/42/EC

Goods should be installed and used in accordance with our instructions
 and with the local and international rules in force. Installation should be
 done by a skilled and registered person for the relevant work.

Winterswijk, 7 Oktober 2013

ir. M. Fisellier
 Manager research and development