

INSTRUCTION MANUAL
AIR HEATER
TYPE DXE

GB 560c

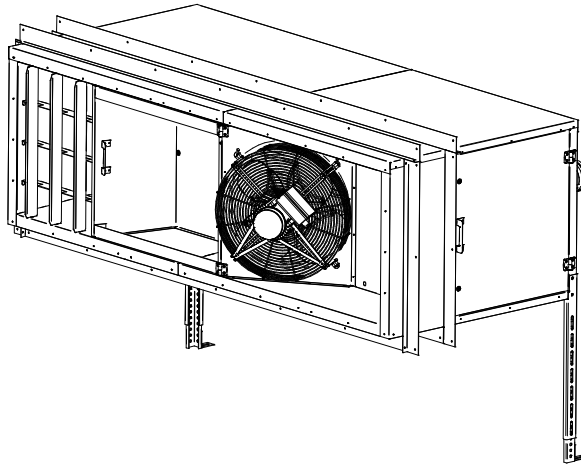

THIS DOCUMENT MUST ABSOLUTELY BE READ BEFORE STARTING THE
INSTALLATION.
INSTRUCT USER AND LEAVE THIS DOCUMENT WITH THE HEATER FOR
REFERENCE.

Manual version GB560c
Heaters for GB
Date: 2017-03
Heaters for natural gas G20, Propane G31 &
Butane G30

1 Introduction:

This installation and user manual contains the installation and users instructions for the standard and axial model of the DXE-series. This manual is produced specifically for the gas, electrical and mechanical installer. Also, it contains instructions how to install, use and maintain the heater. To assure a safe and efficient operation of this unit air heater, it is absolutely necessary to apply the instructions in the manual(s) correctly.

2 Content:

	Page
1 INTRODUCTION:	2
2 CONTENT:	2
2.1 GENERAL	3
2.2 GUARANTEE	3
3 APPLICATION RESTRICTIONS	3
3.1 PRE-CHECK	3
3.2 PROTECTION DEGREE	3
4 TECHNICAL DETAILS:	4
4.1 DXE80 / 100	4
5 INSTALLATION	5
5.1 POSITIONING	5
5.2 GAS CONNECTION	5
5.3 ELECTRICAL CONNECTION	6
5.4 AIR INTAKE / COMBUSTION PRODUCTS DISCHARGE	8
6 FUNCTIONING OF THE UNIT	8
6.1 GENERAL	8
6.2 HEAT DEMAND	8
6.3 VENTILATION	9
6.4 HIGH LIMIT PROTECTION	9
6.5 DESCRIPTION HEATER CONTROL HC	10
7 PUTTING INTO OPERATION AND ADJUSTMENT	11
7.1 GENERAL	11
7.2 HEAT DEMAND	11
7.3 START BY USING THE SERVICE-BUTTON	11
8 ADJUSTING THE GAS-CONTROL	12
9 PROBLEM SOLVING	13
9.1 GENERAL	13
10 MAINTENANCE	15
10.1 BASIC CLEANING THE HEATER	15
10.2 GENERAL MAINTENANCE	15
10.3 SPARE PARTS	16
11 ELECTRICAL DIAGRAM	17
11.1 ON/OFF HEAT DEMAND CONTACT.	17
11.2 HEAT DEMAND CONTACT WITH BUS CONNECTION	18

2.1 General

The DXE heaters are direct fired gas heaters with an output up to 80 (DXE80) or 100kW (DXE100). The heat exchanger is built with S-shaped tubes, each having its own atmospheric burner. Depending on the power of the heater, there are more burners and tubes in one appliance.

Further the heater is provided with a sophisticated control sequence to maintain a safe and reliable operation.

It is imperative that the installation and maintenance of this appliance are carried out by qualified gas engineers, and strictly according to our instructions.

2.2 Guarantee

The guarantee is invalidated when the air heaters are not installed in accordance with this manual.

3 Application restrictions



Important!

The installation and maintenance of this air heater should be performed by an authorized competent installer in accordance with this manual.

This appliance is not intended for use by persons (including children) with reduced physical, sensory or mental capabilities, or lack of experience and knowledge, unless they have been given supervision or instruction concerning use of the appliance by a person responsible for their safety.

3.1 Pre-check

Before unpacking and installation, please check (i.e. on the data badge) if the heater corresponds to the order and if it is suitable for the local present provisions (gas type, gas pressure, electrical supply etc.)

The installation must comply with all applicable local and national standards.

The installation of the air heater must be in accordance with the relevant requirements of the Gas Safety Regulations (for example in GB; The Institute of Gas Engineers IGE UP-1 and 2), Building Regulations and the IIE Regulations also incorporating the gas safety (installation and use) regulations. Other national and/or local regulations may apply (the Local Authority, Fire Officer and Insurers)

The competent installer must make sure the heater operates correctly and must instruct the user about the safe operation of the heater.

The heater should not be installed in areas containing aggressive or explosive vapors. The heater can be used for poultry houses, but has to be cleaned after every batch of animals, or sooner if the pollution degree requires it. Otherwise the guarantee will become invalidated.

The heater has been tested in detail on safety and correct operating settings before leaving the factory. It has been adjusted for the type of gas that is stated on the data badge. Should there be any doubt, please contact your supplier.

3.2 Protection degree

The heater has a protection degree of IPX4D. That means protection against splash water from any direction. That means no water pressure cleaner!

However the heat exchanger can be cleaned by means of a water pressure cleaner.

Do not spray with pressure water on the electrical motor or on the machine cover from the electronics. Those parts can with stand water, but not from a pressure cleaner.

4 Technical details:

4.1 DXE80 / 100

Type		DXE80	DXE100
Maximum nominal heat input (Nett)	kW	83	108
Minimum nominal heat input (Nett)	kW	53,5	73,5
Efficiency max power	%	91,5	91,8
Efficiency min power	%	89,5	89,5
Maximum heat output	kW	75,9	99,1
Minimum heat output	kW	47,9	65,8
Max air output (warm)	m ³ /h	8.000	1.0000
Throw	m	45	50
Sound level	dB(A)	68	68
Electric Connection	Vac	230	230
Thermostat connection (low voltage 24V)		On / Off	On / Off
Power Consumption	W	900	1.400
Power Consumption Amps	A	3,9	6,1
Protection degree		IPX4D	IPX4D
Gas connection	G"	3/4"	3/4"
pressure switch point	Pa	160	180
Flue / air connection	mm	Ø 130	Ø 130
Max. flue amount	kg/hr	150	199
Max. chimney flue pressure	Pa	40	60
Dimensions:	height	mm	1.080
	Width	mm	650
	length	mm	2.100
Weight	kg	150	175
Natural gas G20			
Nominal supply pressure G20	mbar.	20	
Supply pressure (min-max) G20	mbar.	17-60	
Gas category	Cat.	II2H3B/P	
Class	Class.	B22, C12, C32	
Max gas consumption G20	m ³ /hr	8,8	11,4
d injectors	mm	6x Ø 3,7	8x Ø 3,7
Burnerpressure low-high	mbar	3,2-7,4	3,5-7,7
CO2 high (indication)	%	8,3	8,3
NOx class	class	3	3
NOx (@ 0%O2)	mg/kWh	126	135
CO (@ 0%O2)	mg/kWh	134	144
Propane, G31			
Nominal supply pressure G31	mbar.	30-50	
Supply pressure (min-max) G31	mbar.	25-60	
Gas category	Cat.	II2H3B/P	
Class	Class.	B22, C12, C32	
Max gas consumption G31	kg/hr	6,6	8,6
d injectors	mm	6x Ø 2,3	8x Ø 2,3
Burnerpressure low-high	mbar	8,1-19,5	8,5-18,5
CO2 high (indication)	%	9,2	9,5
NOx class	class	3	3
NOx (@ 0%O2)	mg/kWh	139	145
Butane, G30, LPG			
Nominal supply pressure G30 (B/P)	mbar.	30-50	
Supply pressure (min-max) G30 (B/P)	mbar.	25-60	
Gas category	Cat.	II2H3B/P	
Class	Class.	B22, C12, C32	
Max gas consumption G30 (B/P)	kg/hr	5,0	6,5
d injectors	mm	6x Ø 2,3	8x Ø 2,3
Burnerpressure low-high	mbar	6,0-15,0	6,5-14,5
CO2 high (indication)	%	9,2	9,2
NOx class	class	3	3

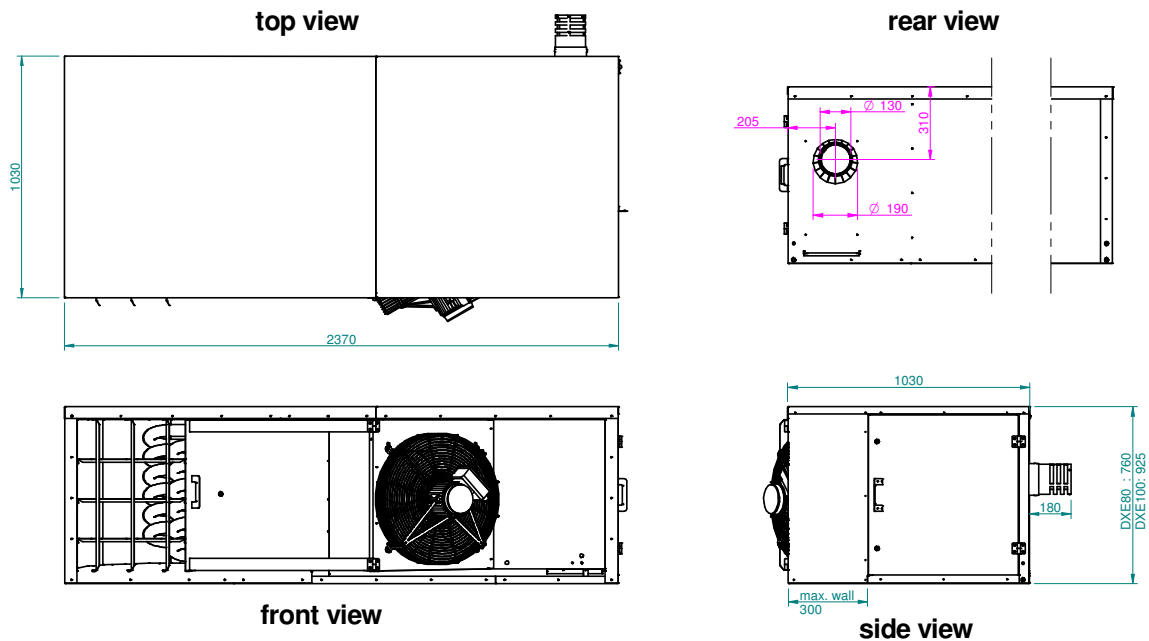

5 Installation

5.1 Positioning

- Check and make sure that the support is solid enough. Keep sufficient distance between the heater and any obstruction. Take into account the possibility to open and access the service doors of the heater for service and cleaning. Pay particular attention to any flammable materials.. Make sure the airflow to and from the heater is unhindered. Make sure that the warm air can be blown out freely. There should absolutely be no (possibility of) materials within 5m from the front of the heater.

- The heater is provided with M10 sockets on the top and on the bottom. See technical drawings.
- Make sure that after fitting, there is no mechanical tension on any connecting gas or electric supplies.
- Install the heater Horizontally

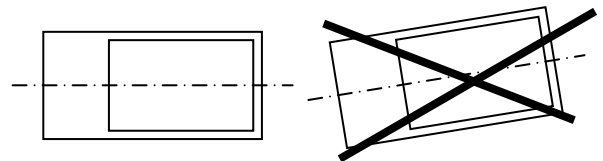

Attention:

See the application-restrictions in this manual (Chapter 4) for more installation restrictions.

5.2 Gas connection

The gas supply line has to meet the national valid requirements and possibly the local requirements of the building inspector, police or fire brigade. (In GB it must comply with Gas Engineers publication UP-1 and UP-2 together with BS 6891.)

A manual isolation valve in the supply line must be placed within reach of the heater, and all gas lines must be mounted without any mechanical tension.

When testing the supply lines with pressures above 60 mbar, this manual valve at the heater must be closed.

The working and standing supply pressure must be between 17mbar and 30mbar, measured at the inlet pressure nipple of the gas control in the heater.

The burner pressure is pre-adjusted (high/low, see technical details). The burner pressure can be measured on the P-out measure point on the gas valve.

5.2.1 Changing the gas type



There is a kit available for changing the gas type. (from natural gas to propane or vice versa) The gas nozzles have to be exchanged and the burner pressure readjusted. Look into the specifications for the exact adjustments. Instructions can be found in this manual.

5.3 Electrical connection

5.3.1 230Vac supply



The installation must comply with local and national requirements, (as well as IEE regulations). The unit heater is delivered completely internally wired. Where controls of any type are to be added (e.g. room thermostat), the relevant wiring diagrams must be followed. Never use a room thermostat to interrupt the electrical supply to the heater!



The supply is 230Vac 50Hz with earth. When the supply voltage is lower than 195V and higher than 255V the correct functioning of the heater is not guaranteed.

A mains cable including plug is supplied with the heater. The wires of the cable must be connected to the clamps in the connection box. Make sure you do not damage the mains cable. Replace a damaged cable immediately.

When the heater is connected without a plug, make provisions to completely isolate the heater for maintenance purposes. This can be an isolation switch (min. 3mm contact opening gap). The switch should not interrupt earth.

Ensure the plug or switch is located within a 2m radius of the heater and the plug can be removed easily and quickly from the socket

5.3.2 Thermostat connection

The heater can be controlled in 2 ways.

1. Controlled by an ON / OFF signal
2. controlled through a bus system by an external interface

5.3.3 Thermostat cable

In all cases the communication between the heater and the thermostat is based on a two wire, low-voltage connection. (see also electrical wiring diagram).



Cable specification: signal cable, 1x2x0,8 (shielded and twisted)
Maximum length 200m.

If the chosen cable is too thin, the signal will be too weak and heater will not work. If the cable is not shielded and twisted the signal might become disturbed in an EMC unfriendly environment. Keep the thermostat cable separated from mains cables. Connect the earth shield of the cable only to the earth terminal in the heater.

If these guidelines are not followed it may result in malfunction of the installation or worse, it could damage the thermostat or the electronics in the heater.

5.3.4 ON / OFF thermostat signal (standard configuration)

(standard configuration see schematic R130 version D, connection 4 - 5 → RT)

The heater has an 24V thermostat circuit. When the contact between the clamps 4 and 5 are closed the heater will start.

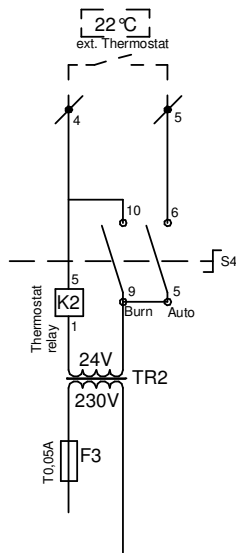

Internal circuit: Inside the heater there is a 24V transformer and a relay. The transformer supplies the 24V signal for the thermostat circuit and the relay gives the electronics the heat demand. This relay is also a boundary for external signals that can damage the electronics.

Every heater has to be switched by a **separate** low voltage ON/OFF contact in the control room

Do not connect more than 1 heater under 1 contact.

The main board should be set as follows: (= standard configuration)

- The S2 micro switches on the main board have to be set to OFF, see example.
- The switch S3 has to be set to 1.



- The thermostat has to be connected to the clamps 4 and 5 in the heater.

(Any changes too these switches must be performed with the power off, otherwise the changes will not have effect.)

5.3.5 Controlling through an Interface with extra connectivity

The heater can also work with extra connectivity. By means of an external interface the following signals are available:

- ON/OFF demand
- Reset
- Ventilation only
- Error signal
- Flame signal

This interface can control up to 8 heaters at the same time.

As **this is not the standard configuration**, different settings need to be made.

(see schematic R140 version A, connection 6 – 7 bus port)



1. DO NOT CONNECT the communication bus to clamps 4 and 5. Use clamps 6 and 7 instead!

2. REMOVE the relay K2 from its socket

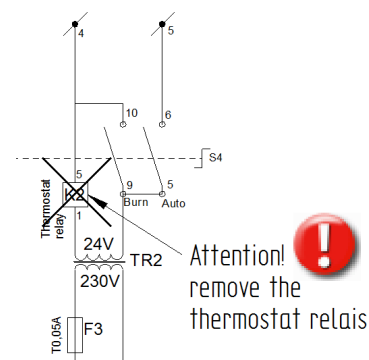
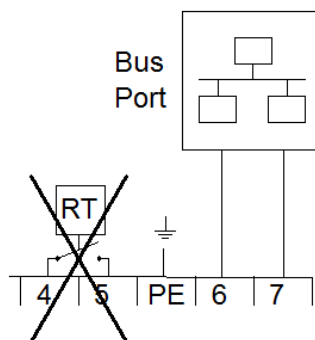

3. Change the settings from the switches on the control unit in the heater.

Each heater needs to have its own unique number to be recognised by the interface. The number of the heater can be set by the micro switch S2 on the heater control in the heater. The number at the upper position of the switch is the given number for that heater. Make sure that each heater has its own unique number. If more than one heater has the same number the system will not work.

Any changes to these switches must be performed with the power off, otherwise any changes made will not take effect.

The switch S3 has to be set to 0 (off) for the heaters 2 to 8

It is possible, that with incorrect settings, the system is working. However, ultimately the equipment will be damaged and stop working.

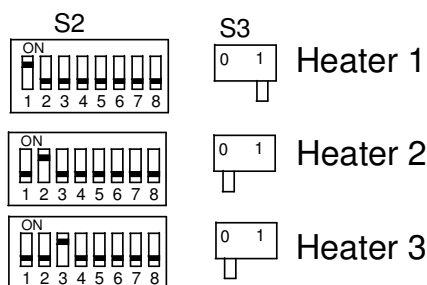

Position  **3 “burn”** on the manual mode switch on the heater doesn't work anymore in this situation!

5.3.6 Fuses

On the heater control (HC) there are two fuses. (See electrical wiring diagram.)

F1 and F2 (T5A) are in the power supply of the heater. Replace the fuse only by a fuse of the same type. The fuse F3 (T0,05A) protects the 24V transformer in the thermostat circuit

5.4 Air intake / combustion products discharge

Check for compliance with local/national regulations.

The unit has an internal combined combustion-air supply and a combustion-gas outlet device (wall terminal). Only in this way the installation is CE approved. See installation drawings.

Never connect another terminal to the appliance.

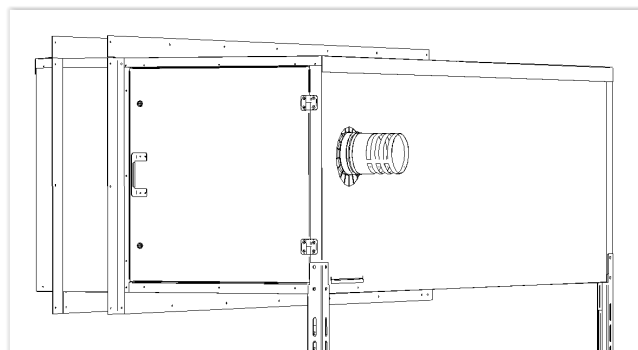

6 Functioning of the unit

6.1 General

The unit can heat as well as ventilate. The mode that the heater should work on can be selected by means of the control switch on the heater.

6.2 Heat demand

If the thermostat indicates heat demand, the following cycle will start:

- 1. Pre purge:** The electronic circuit board acknowledges the heat-demand and the flue booster fan will start running for 30 seconds. (Display print → 1)
- 2. Ignition:** After 30 seconds of pre purge, the electrode will spark for max. 5 seconds, the gas valve is opened and the gas-air mixture will ignite. (Display print → 2)
- 3. Burn:** When the flame is detected (Display print → b) the unit will modulate to the desired load after ca. 15 seconds. Depending on the given load, the system fan will start modulating (step-less) as well. The air heater will **always run for a minimum of 1 minute**. This is to evaporate eventual condense in the discharge system.
- 4. End of heat demand:** When the heat demand ends, the burner will switch off and the system fan will continue to run for ca. 3 minutes in order to cool the unit down (Display print → P).

The unit will try to ignite twice before lockout on flame fault.
In the case of flame failure during operation, the heater will attempt one restart.
When the heater is in lockout you see in the display intermittent A1. On the display of the room thermostat you see failure 1.

6.3 Ventilation

With the control switch on the heater the unit can be set to the ventilation mode. In that way the unit will always ventilate. A heat demand is also acknowledged. So the heater will still burn when necessary.

6.4 High limit protection

The unit is equipped with a temperature sensor. This NTC sensor is mounted in the front of the heater. It monitors the air temperature electronically.

There are 4 important temperature levels detected by this sensor.

1. Temperature lower than 80 °C
 - Normal functioning.
2. Temperature between 80 °C and 90 °C
 - Burner at minimum stage
3. Temperature between 90 °C and 110 °C:
 - Error E1 will blink on the display.
 - The burner is switched off
 - The fan cools the heater
 - When the temperature is below 70 °C degrees, the heater will automatically restart. The Error E1 will disappear.
4. Temperature above 110 °C
 - Error A2 will appear on the display
 - The burner had already stopped
 - The fan was already cooling the heater down.
 - When the heater cooled below 70 °C the heater will not restart automatically.
This error can only be reset manually.

6.5 Description heater control HC

The heater control (HC) controls the unit and communicates with the room thermostat.

Functions integrated in the heater control HC are:

- two wire contact with room thermostat
- spark ignition to burner
- ionisation flame guard on burner
- controlling the gas valve
- modulating the burner
- controlling the system fan
- guarding the temperature of the heat exchanger
- LED signals status of heater, heat demand: green, failure: red
- Status of heater on 8 segment display on heater control HC
- reset of heater
- service mode function

Lay-out print board

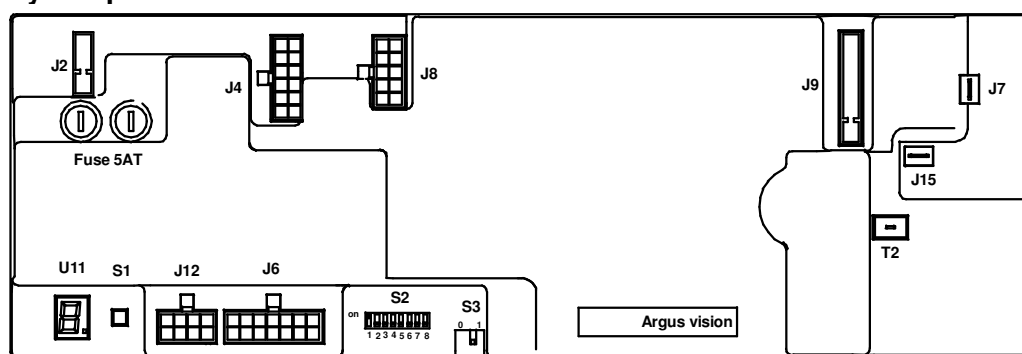

J2 Main power connection 230V

J4 Connection for gas valve and system fan

J6 Connection for room thermostat, appliance recognition and the status LEDs green and red

J7 Earth burner

J8 Modulating coil gas valve, flue booster

J9 not used

J12 Connections for temperature sensors

J15 Ionisation selector

F1 & F2 Fuses 2x 5AT

U11 Status display

S1 Reset service button

S2 Micro switch heater no. Standard all to OFF

S3 Power supply thermostat when S2 no.1 to "on"

T2 Ignition transformer, connection for igniters

7 Putting into operation and adjustment

7.1 General

Prior to packaging, each unit is checked in detail on safety and well functioning. It is among other things adjusted to the right efficiency of combustion. In general, the heater does not need to be adjusted after installation, only a check of well functioning is necessary by a competent person.

The high/low burner pressures can be adapted, if necessary. However, only do this when the burner pressure turns out to be incorrect after measuring (differences smaller than 0,5mbar do not need to be adjusted). Never touch the adjusters injudiciously!

In case the installation is done following these instructions, the unit can be put on. Make sure the gas line is clean, gastight and free from air.

Turn on the electrical supply with the main switch, and leave the door of the heater open, in order to watch the first start and so become familiar with the functioning of the unit.

In case of warmth demand, the heater will always run for at least 4 minutes, even if the warmth demand is fulfilled within this time.

The heater will attempt twice to start again, before going on flame failure. Then reset is necessary.

Do not forget to instruct the end user about a safe use of the heater (presence of gas, place of the manual gas valve!), the operation of the heater (lock-out indication and reset) and about the necessary maintenance. This manual must be left with the end user.

7.2 Heat demand

If the thermostat indicates heat demand, the following cycle will start:

5. **Pre purge:** The electronic circuit board acknowledges the heat-demand and the flue booster fan will start running for 30 seconds. (Display print → 1)
6. **Ignition:** After 30 seconds of pre purge, the electrode will spark for max. 5 seconds, the gas valve is opened and the gas-air mixture will ignite. (Display print → 2)
7. **Burn:** When the flame is detected (Display print → b) the unit will modulate to the desired load after ca. 15 seconds. Depending on the given load, the system fan will start modulating (step-less) as well. The air heater will **always run for a minimum of 1 minute**. This is to evaporate eventual condense in the discharge system.
8. **End of heat demand:** When the heat demand ends, the burner will switch off and the system fan will continue to run for ca. 3 minutes in order to cool the unit down (Display print → P).

The unit will try to ignite twice before lockout on flame fault.

In the case of flame failure during operation, the heater will attempt one restart.

When the heater is in lockout you see in the display intermittent A1. On the display of the room thermostat you see failure 1.

7.3 Start by using the service-button

Besides operating with the function switch, the heater can also be started from the service button on the print board, near the display. Press the service-button once for 10 seconds, and the unit will commence the ignition-cycle; (30 seconds pre-purge, ignition, then burn)



The burner will then start on minimum load Display blinking → L/b.

By pressing the service-button again, the burner will go to maximum load. Display print → H/b

Pressing the service-button for a third time will put the unit back into normal operation (depending on if there is heat demand from the room thermostat).

Display on the print board

0	stand-by	Stand-by
1	Pre-purge	System checks and 30 sec. pre purge of the fluebooster
2	Ignition	The ignitionelectrode sparks 5 sec. and the gas valve opens, within 5 sec. flame detection should occur.
b	Burn	After 15 sec. stabilisation time, the heater will modulate to the desired power. The heater will run at least 4 minutes.
P	Post purge	The heater will cool the heat exchanger for 3 minutes, and the fluebooster will post purge for 1 minute.
F	Summer ventilation	The system fan is running on the summer ventilation mode.
L/1/2/ ... Blinking	Service Low	The heater is running on the service mode. When the heater runs, the heater will run on minimum power.
H/1/2/ ...Blinking	Service High	The heater is running on the service mode. When the heater runs, the heater will run on maximum power.

8 Adjusting the gas-control

In principle, it is **not** necessary to adjust the gas control after putting the unit into operation. In case it needs to be adjusted, (e.g. after fitting a new one), this must be done only by a qualified person. **Only use calibrated instruments!** A poor adjustment can lead to overheating and / or production of toxic carbon monoxide!

The burner pressures can be adjusted as follows:

- Remove the cover from the gas control with the help of a (small) screwdriver.
- Start the unit and first set the high burner pressure by turning screw (external 10mm). The High / low coil must be energized !
- De-energize coil (disconnect wire) and set low burner pressure by turning screw (slot for screwdriver) Do not set lower than 3 mbar in order to avoid problems with inter-lightning of burner strips.

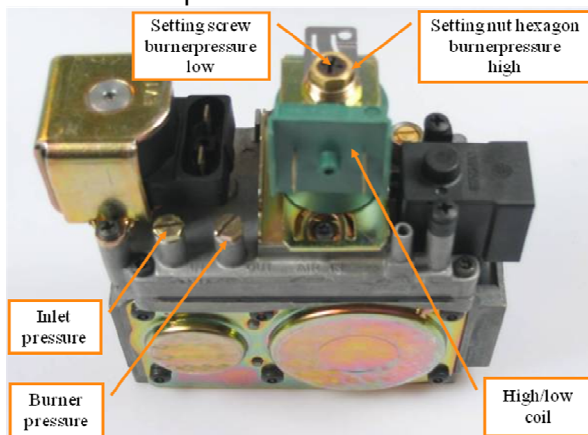

Attention: Always check each burner pressure after any adjustment, as they influence each other.

Always check the CO production of the heater!!! Too much CO usually means the mixture is too rich. Adjust this if necessary with the two adjusters (see above)

9 Problem solving

9.1 General

When it turns out that the problem is **not** caused by the external circumstances (i.e. no electric supply power or no gas), please take the following instructions into account. Please remember the built in waiting times of the heater (do not react too soon!) and the code on the display on the electronic circuit board.

To simplify the investigation of the failing heater please check first:

- the fuses as well as the wires and plugs in the heater for possible loose contacts.
 - Use first the service-button to put the heater in run mode, try later the room thermostat.

Volatile lock out : Can only be reset by hand

A/0 Blinking	Internal failure	Defective print board
A/1 Blinking	No flame	Within 5 sec flame, then flame failure: Cause 1 No flame: Cause 2
A/2 Blinking	Exchanger too hot	Heater stops because the temperature of the heat exchanger is too high: Cause 3
A/3 Blinking	Sensor error	Temperature sensor on heat exchanger error: Cause 4
A/4 Blinking	Too many flame failures	Too many flame failures on ionization: Cause 1, 5
A/5 Blinking	Internal error	Defective print board
A/6 Blinking	Safety relays	2nd temperature limiter (optional) switched: Cause 3, 10
A/7 Blinking	Flame	Flame detection when there should not be a flame
A/8 Blinking	Fluebooster	Fluebooster does not run: Cause 6 Fluebooster runs: Cause 7

Non volatile lockout: will disappear when the error is cleared.

E/0 Blinking	Internal defect	Defective print board
E/1 Blinking	1st temperature safety	Heater stops because the temperature of the heat exchanger is too high. When the heater is cooled down, the heater will restart: Cause 3
E/2 Blinking	Selection resistance	Heater recognition does not work: Cause 8
E/3 Blinking	Selection resistance	Heater recognition does not work: Cause 8
E/9 Blinking	Reset error	Too many switches on reset button: Cause 9

Cause 1: Within 5 sec flame, then flames failure.

- The flame is not detected. Check the ignition cable and electrode. (cable resistance 1K ohm)
- The heater has electrically a poor earth.
- The print board is defective.

Cause 2:

- There is not enough gas pressure.
- The burner pressure is too low, adjust the gas valve
- The gas valve does not open, check during ignition on 230V on the valve.
- Check whether the ignition electrode sparks, replace cable, electrode

Cause 3: Heat exchanger too hot

- Check if the system fan blows enough air.
- Check the setting of the gas valve, the heater may be overloaded.

Cause 4: Temperature sensor on heat exchanger error.

- The sensor has internally 2 sensors. These differ too much. Measure the resistance from each sensor, the resistance should be 20K at 25° en 25K at 20°. If the measured values differ too much, replace sensor.
- Rotate the sensor ¼ turn, so that the contact point is different on the sensor housing.

Cause 5: Too many flame failures while burning

- The setting of the gas valve is not ok, adjust the gas valve
- The flue outlet is blocked

Cause 6: The flue booster does not run

- fan is blocked or the wiring is bad
- fan is defective

Cause 7: The flue booster fan runs.

- Check if the fan runs smoothly.
- Check if the fan is not polluted.
- Check if there is water (condense) in the hoses from the pressure switch.

Cause 8: Selection resistance error

- Check the appliance recognition part, replace if necessary

Cause 9: Reset button error

- Too many switches on reset button in a short period of time. This error will disappear after some time, or if the main power is disconnected for a while.

Cause 10: 2nd STB (optional) switched

- Heaters equipped with 2 system fans have a second temperature limiter. The second limiter has switched. Check the fan where this sensor is mounted.
- Check the wiring.

Heater does start, but shows other problems.

- a) System fan (M1) does not start. Check first the functioning of this fan by connecting it to 230 Volt. Check with a multi-meter if the different lower tensions are present on the fan. The fuse could have failed. If the motor is OK, the cause of the problem must be in the heater control HC, as the heater control HC dictates the different voltages to the fan-motor. In that case, replace the heater control HC.

10 Maintenance

It is recommended to have the heater checked and serviced by a service technician every year to guarantee reliable and safe operation. Heaters used in poultry sheds must be serviced and cleaned more often due to high levels of dust and dirt in these types of spaces.

10.1 Basic cleaning the heater



The heater must be disconnected from electricity during servicing. Disconnect the heater from the main power.

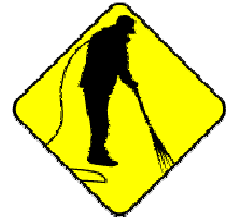

The heater can be cleaned with water. And some parts can withstand a pressure washer.

Do not spray with a pressure washer on the following parts:

- The big fan motor on the top of the heater. (the connection box will leak due to a pressure washer.
- The cabinet from the electronics. The rubber sealing from the access door will leak with a pressure washer.
- Be careful with the temperature sensor in the front of the heater. Do not spray too close on the wiring to the sensor.

The heat exchanger can be cleaned with a water pressure washer. The access doors will give a good view on the tubular exchanger.

10.2 General maintenance



To ensure the instructions below are carried out safely, it is recommended having these carried out exclusively by a service technician.



The heater must be free of electricity during servicing. Disconnect the heater from the main power.

Perform the following activities during general maintenance:



- Make sure the heater has been cleaned.
- Grease any parts and bolts that are loosened regularly for maintenance.
- Check whether the wiring, nuts and bolts are all properly tightened.
- Open the gas supply to the heater and check whether the heater and the gas hose and other connections are gas-tight.

Finally, carry out all the checks that are performed during heater installation (refer to Performing checks :

1. Measure the burner pressure;
2. Measure combustion values;
3. General heater operation.

Close the access panel once you have completed all checks. The heater may now be used again.

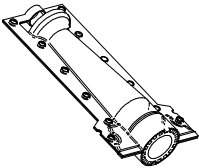
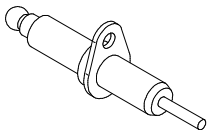
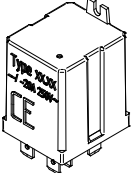
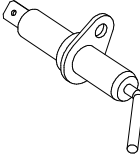
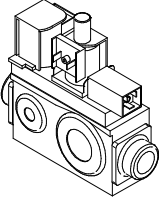
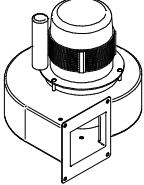
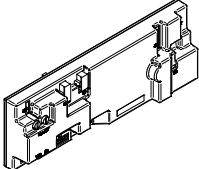
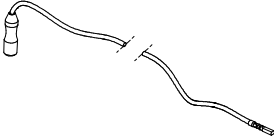
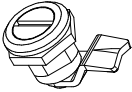
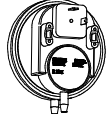
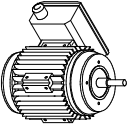
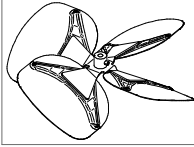
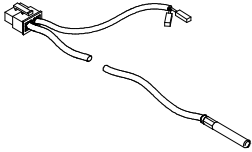
10.3 Spare parts

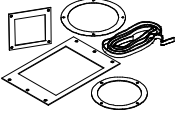
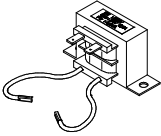
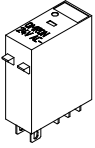
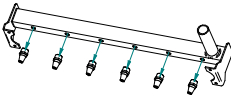
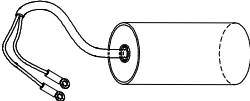
<p>Inshot Burners L Natural Gas / Propane</p> <p>IB3204</p> 	<p>Ignition electrode TR, DXC</p> <p>IB3400</p> 
<p>Fan relay 230V~20A</p> <p>IK5200</p> 	<p>Ionisation electrode TR, DXC</p> <p>IB3402</p> 
<p>Gas valve</p> <p>GA3314</p> 	<p>Flue fan</p> <p>DXE 80: IB4516 DXE100: IB4517</p> 
<p>Control Board</p> <p>GD5908</p> 	<p>Ignition cable</p> <p>IB3929</p> 
<p>Lock</p> <p>IK6850</p> 	<p>Pressure switch</p> <p>DXE80 : IB3902 165/150 Pa DXE100 : IB3904 192/180 Pa</p> 
<p>Fan motor</p> <p>DXE80 : IP4801 DXE100 : IP4813</p> 	<p>Fan blade</p> <p>DXE80 : IK4214 Ø508 30° DXE100 : IK4223 Ø508 40°</p> 
<p>Temperature sensor</p> <p>GD3923</p> 	<p>Flue fan capacitor</p> <p>DXE80 : IB4520 DXE100: IB4521</p> 
<p>Gasket set</p> <p>GA6716</p> 	<p>Transformer 230/24V: GD5103</p> <p>Fuse: 5x20 250V T 50mA: IK5879</p> 
<p>Thermostat relay 24V</p> <p>IK5228</p> 	<p>Conversion kit natural gas → propane</p> <p>DXE 80 : GA7437 DXE100 : GA7439</p> 
<p>Motor Capacitor main fan</p> <p>DXE80 : IP4815 DXE100 : IP4817</p> 	

11 Electrical diagram

11.1 On/Off heat demand contact.

Standard configuration

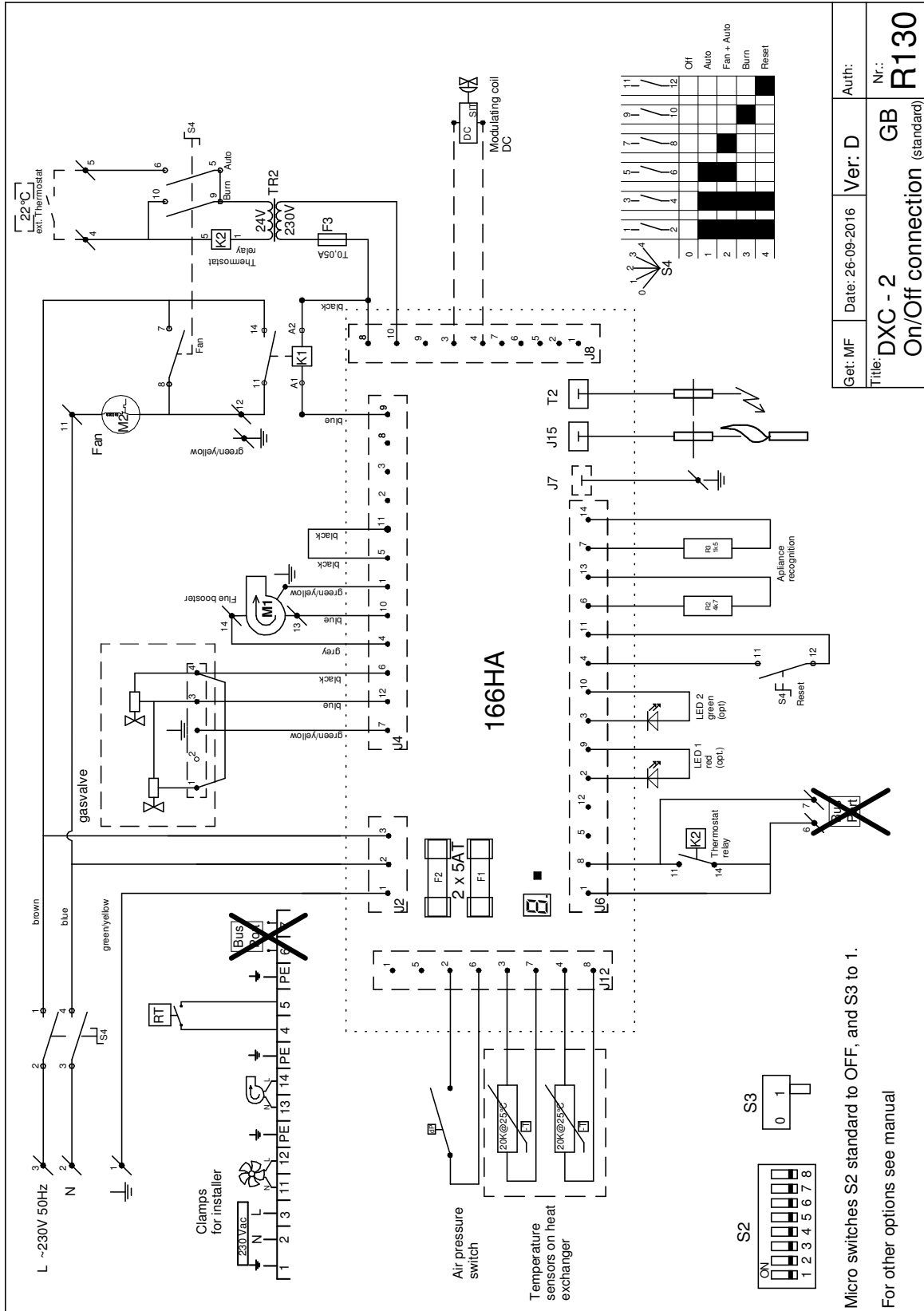

Get: MF Date: 26-09-2016 Ver: D Auth:

Title: **DXC - 2** GB **R130**
On/Off connection (standard)

11.2 Heat demand contact with bus connection

Not the standard configuration

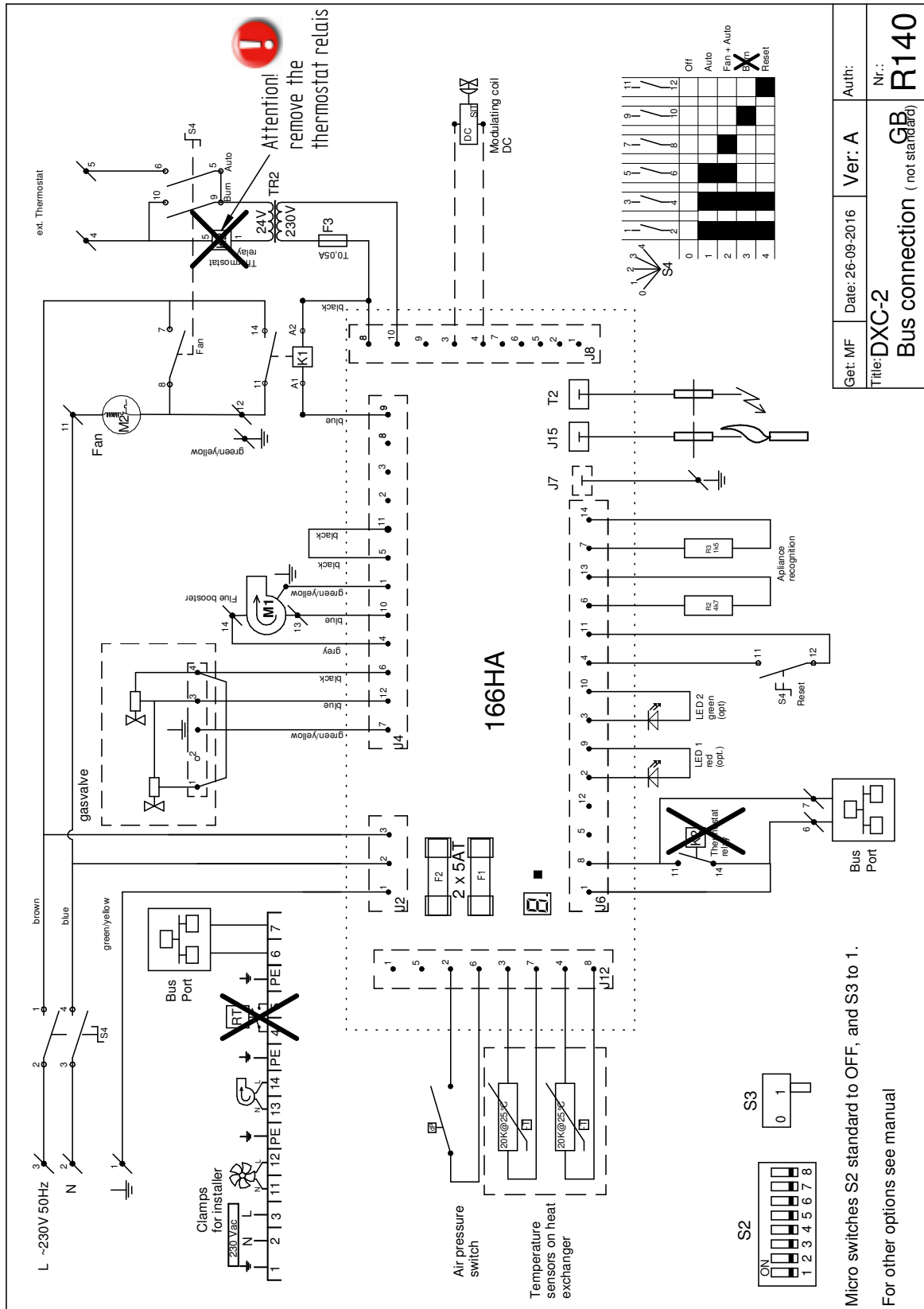

Get: MF	Date: 26-09-2016	Ver: A	Auth:
Title: DXC-2			
Bus connection (not standard)			
Nr.: GB R140			